



# Manumed Optimal 3-section

The most versatile  
treatment and  
examination couch



PARTNER FOR LIFE

# Manumed Optimal 3-section

The versatility of the Manumed Optimal 3-section offers you, the modern and demanding physiotherapist, the perfect treatment and examination couch. Everything is possible: lying and sitting positions, Trendelenburg and flexion position, which can be adjusted during treatment with the patient simply remaining on the couch. In short, the most universal couch available, which gives both the therapist and the patient the experience of comfortable treatment. Elegant in appearance and sturdy on its retractable castors, the Manumed Optimal 3-section is the obvious choice for the therapist who makes high demands on a professional top quality treatment couch.



"A fantastic all-round examination and treatment couch"



## Manumed Optimal 3-section

- 3 (to 5) adjustable sections
- Many adjustable positions, including the flexion- and (anti-) Trendelenburg positions
- Electrically adjustable pli comes standard with electrical high/low variant
- Load capacity up to 200 kg (some models optional to 250 kg)
- Head section folds down completely for better access of the cervical region
- Optimally positioned handles
- Long nose hole, allowing proximal or distal movement of the patient even when lying in prone position
- Optional a triangular nose hole or without nose hole
- Wheel raising mechanism for easy movement of the couch
- Height can be adjusted hydraulically (no mains lead needed) or electrically (very convenient, smooth and quick)
- Completely relaxed starting position in the face-down position with separate head section (optional)

# Manumed Optimal 3-section without flexion position

## Type

212 3-section without flexion-position, hydraulic H/L

222 3-section without flexion-position, electric H/L



## ORDERING DATA

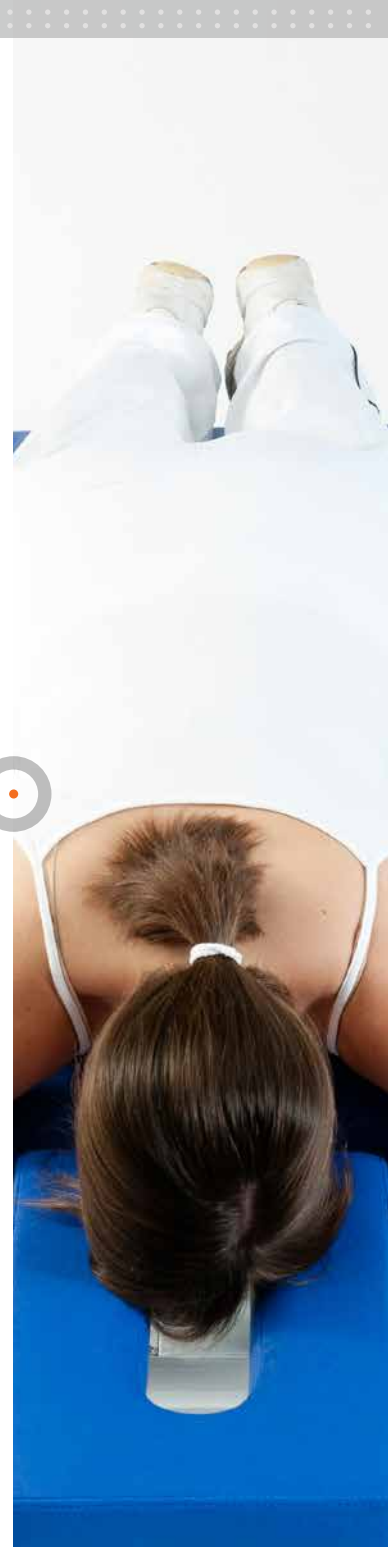

# Manumed Optimal 3-section with flexion position

## Type

213 3-section, gasspring supported flexion-position, hydraulic H/L

243 3-section, electric flexion-position and electric H/L

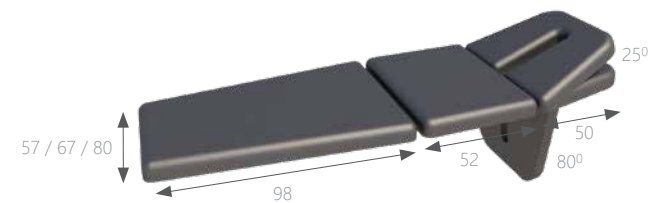

## ORDERING DATA



# Manumed Optimal 3-section with flexion position and with adjustable arm sections

## ORDERING DATA

### Type

- 214 3-section, head-section with adjustable arm sections, without flexion position, hydraulic H/L
- 224 3-section, head-section with adjustable arm sections, without flexion-position, electric H/L
- 215 3-section, head-section with adjustable arm sections, gasspring supported flexion position, hydraulic H/L
- 245 3-section, head-section with adjustable arm sections, with electric flexion position, electric H/L

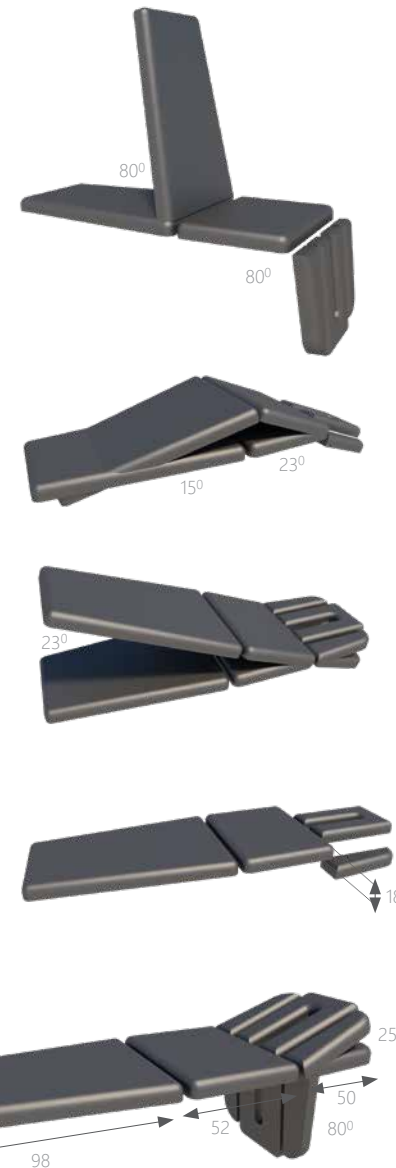

# Manumed Optimal 3-section

## TECHNICAL SPECIFICATIONS

|                           |  |
|---------------------------|--|
| Size tabletop (lxw):      | 204 x 67 cm (optional 57 or 80 cm width)     |
| Height adjustment:        | 47-100 cm electric<br>47-97 cm hydraulic     |
| Lifting time (min.-max.): | approximately 18 sec.                        |
| Lifting capacity:         | 200 kg<br>(electrical motor optional 250 kg) |
| Power supply:             | 120/230VAC 50/60 Hz                          |
| Current consumption:      | 2.0 A max.                                   |

NOTE: ALL-AROUND OPERATION IS AN OPTION.

This is a medical device  
**CE**

It complies with all applicable medical regulations. For more details please consult the instructions for use (downloadable via [www.enraf-nonius.com](http://www.enraf-nonius.com)).



# Manumed Colours

## OPTIONS<sup>(1)</sup>

A matching Enraf-Nonius couch for every interior. As in other practices, a pleasant ambience is important in physiotherapy practices. Clients must feel comfortable in the room where they are being treated. As each practice is furnished differently and has its own colour scheme, we regard it as important for the treatment couches to fit in with your look and feel. That is why we can manufacture our treatment couches in several frame and upholstery colours. Our imitation leather upholstery contains no phthalates and is flame retardant – a unique combination that makes this material suitable for medical use!

### NATURAL

- 811 volcano black
- 850 walnut
- 851 sand
- 886 leaf
- 888 snow

### LIFESTYLE

- 410 anthracit
- 406 petrol
- 407 cherry
- 408 terracotta
- 409 skin

### EXECUTIVE

- 012 black
- 213 grey
- 199 lavender
- 204 sirius blue
- 169 cornflower blue
- 170 baby blue

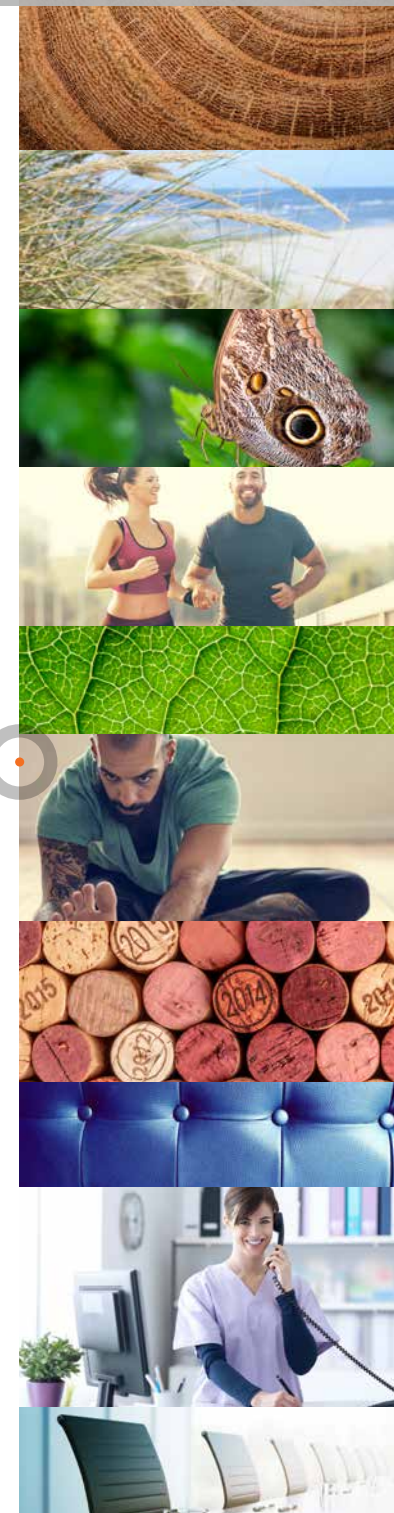

(1) = NOTE: Please order options together with the couch because of modification of the couch during production.

# Manumed Colours

## NATURAL



811 volcano black



850 walnut



851 sand

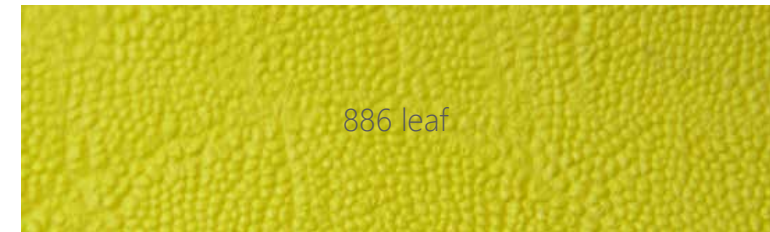

886 leaf



888 snow



# Manumed Colours

## LIFESTYLE



410 anthracit

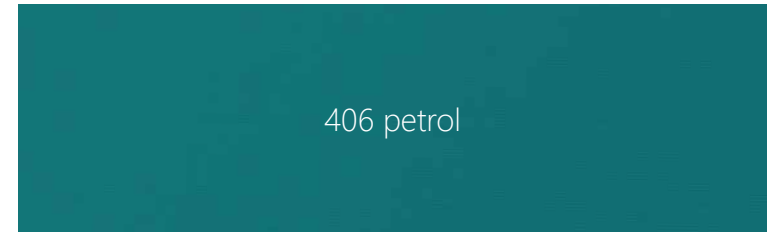

406 petrol

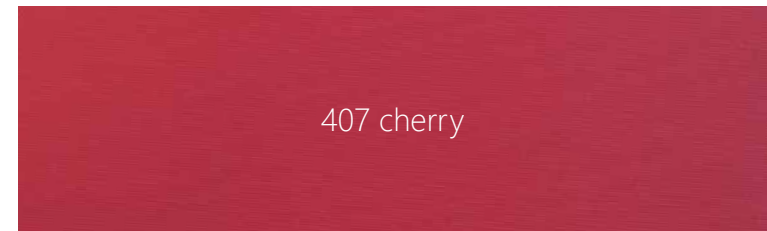

407 cherry



408 terracotta

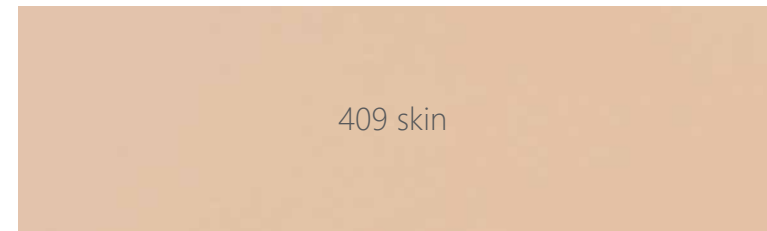

409 skin

# Manumed Colours

## EXECUTIVE



012 black



213 grey



199 lavender

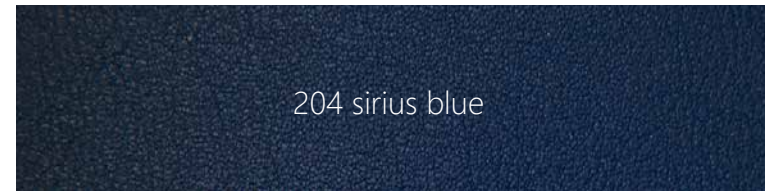

204 sirius blue

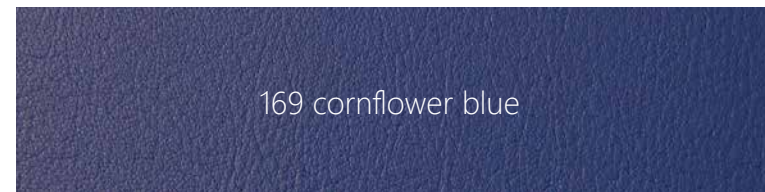

169 cornflower blue

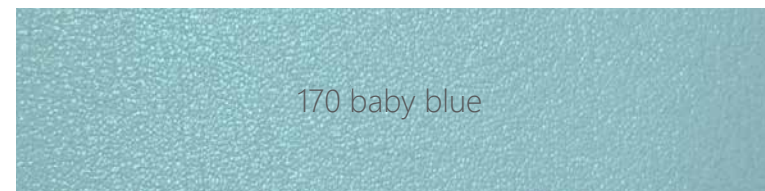

170 baby blue

## Frame colours

- Ral 7035 grey
- Ral 9005 black
- Ral 9010 white

## OPTIONS<sup>(1)</sup>



(1) = NOTE: Please order options together with the couch because of modification of the couch during production.

# Manumed Optimal 3-section

OPTIONS<sup>(1)</sup>

## Upholstery options

| Section Width                  | 57 cm | 67 cm | 80 cm |
|--------------------------------|-------|-------|-------|
| Standard 4 cm thick            | s     | s     | s     |
| DeLuxe 6 cm thick              | o     | o     | o     |
| Extra hard 4 cm thick          | o     | o     | o     |
| Extra soft 5,5 cm thick        | o     | o     | o     |
| Trapzium shaped leg section    | x     | s     | s     |
| Rectangular shaped leg section | s     | o     | x     |

s = standard o = optional x = not available

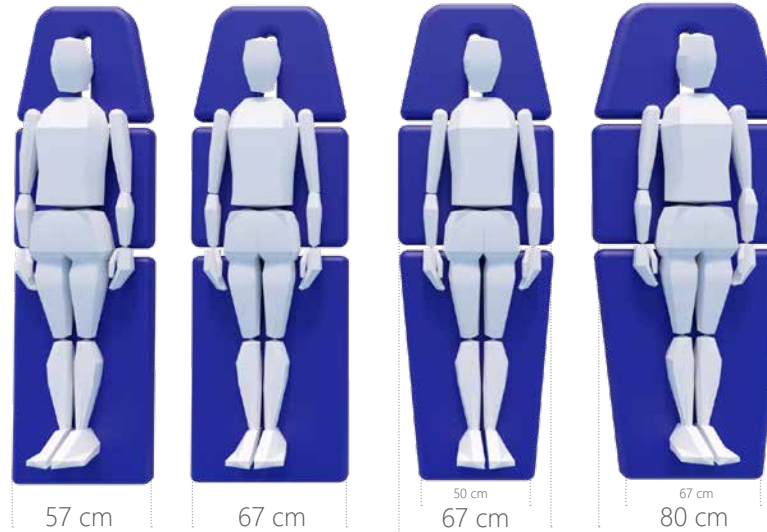

## Foam density:

|             |   |
|-------------|---|
| Standard:   | 38 Kg/m <sup>3</sup>                                    |
| DeLuxe:     | 38 Kg/m <sup>3</sup>                                    |
| Extra hard: | 70 Kg/m <sup>3</sup>                                    |
| Extra soft: | 4 cm 38 Kg/m <sup>3</sup> + 1,5 cm 30 Kg/m <sup>3</sup> |

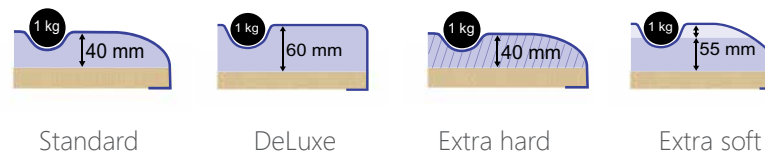

(1) = NOTE: Please order options together with the couch because of modification of the couch during production



# Manumed Optimal 3-section

OPTIONS<sup>(1)</sup>

## Nose-hole

- A. Oblong nose-hole including plug (standard)
- B. Triangular shaped nose-hole (optional) excluding plug, please order separately 1550813
- C. No nose-hole (optional)

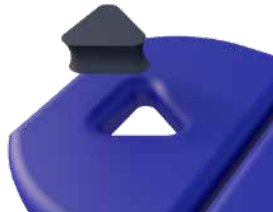

1550813

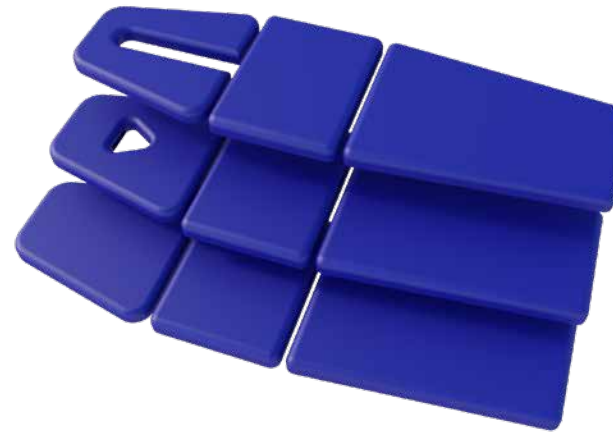

## Height adjustment

- A. Hydraulic types 212 / 213 / 214 / 215
- B. Electric (222 / 243 / 224 / 245) Footswitch (standard)
- C. Electric (222 / 243 / 224 / 245) All-around (optional)



A



B



C

(1) = NOTE: Please order options together with the couch because of modification of the couch during production

# Manumed Optimal 3-section

## OPTIONS<sup>(1)</sup>

### Lifting capacity

- A. Electric - max. 200 kg (standard)
- B. Electric - max 250 kg (optional)
- C. Hydraulic max 200 kg



A



B



C

### Optional features

- A. Ergo-wings (only for 67 cm width)
- B. AutoLock safety system with timer



A



B

(1) = NOTE: Please order options together with the couch because of modification of the couch during production

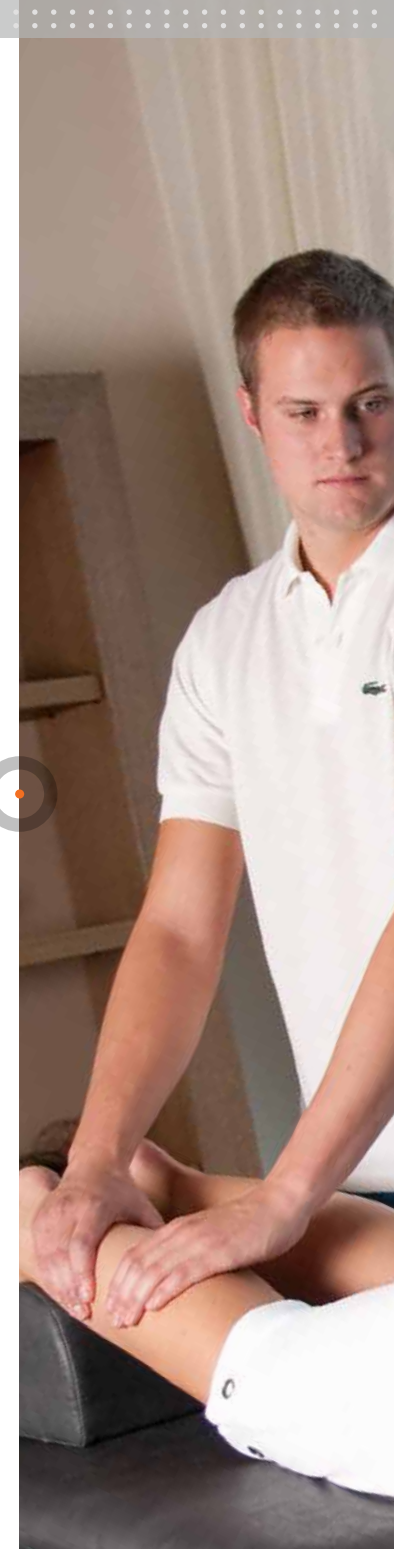

# Manumed Optimal 3-section

## ACCESSORIES

### Paper roll holder and paper rolls

- 3450104 Paper roll holder for Manumed Optimal, for 50 & 60 cm rolls, mounted onder foot-section
- 3450105 Paper roll holder for Manumed Optimal, for 50 & 60 cm rolls, mounted under headsection
- 3445278 Paper roll, width 50 cm, roll-length 150 m, per 5 rolls
- 3445279 Paper roll, width 60 cm, roll-length 150 m, per 5 rolls



3450104



3450105



3445278 / 3445279



# Manumed Optimal 3-section

## ACCESSORIES

### Fixation accessories

- 3xxx035 Shoulder/neck support, set of 2 (available in different colours, see page Manumed Colours)
- 3450036 Clamp for fixation horn 3xxx035 (2 pieces)
- 3xxx031 Pelvic support incl. mounting bracket (available in different colours, see page Manumed Colours)
- 3496187 Fixation rail for fixation horn armpit or gynaecological set: (1550810 / 1550805 / 3xxx028)\*
- 3XXX028 Armpit fixation horn (available in different colours, see page Manumed Colours)



3xxx035

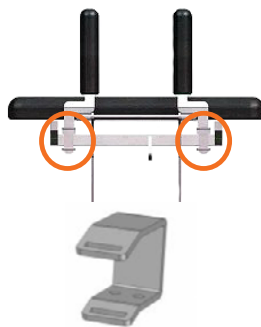

3450036



3xxx031

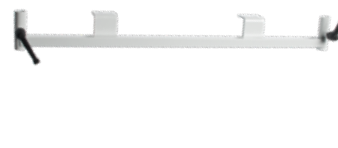

3496187



3XXX028



\* Only for couches 213, 215, 243 und 245

# Manumed Optimal 3-section

## ACCESSORIES

### Fixation straps

- 3445023 Fixation strap with velcro fastener 120 cm
- 3445014 Fixation strap with velcro fastener 160 cm
- 3445015 Fixation strap with velcro fastener 240 cm
- 3445475 Fixation strap with safety lock 250 cm
- 3445474 Fixation strap with safety lock 350 cm



3445023



3445014 / 3445015



3445474 / 3445475



# Stools

# ACCESSORIES

- 3xxx010 Stool, height adjustable 40-53 cm
- 3xxx011 Stool, mobile, height adjustable 59-85 cm
- 3xxx012 Stool, mobile, provided with footrest, height adjustable 59-85 cm
- 3xxx013 Stool, mobile, anatomic seat, height adjustable 50-63 cm
- 3xxx020 Stool, mobile, saddle seat, height adjustable 59-85 cm



3xxx010



3xxx011



3xxx012



3xxx013



3xxx020

Available in all colours shown below

| NATURAL   | LIFESTYLE   | EXECUTIVE  |
|---|---|--|
|  811  851 |  410  408 |  012  213  199  204  169  170 |



## Rolls and cushions

## ACCESSORIES

|         |  |             |
|---------|--|-------------|
| 3xxx002 | Halfroll, flat bottom, small, especially for the ankle | 28x9x11 cm  |
| 3xxx003 | Halfroll, flat bottom, large                           | 56x16x18 cm |
| 3xxx023 | Massage roll   | 50x Ø15 cm  |
| 3xxx004 | Neck cushion, hourglass type                           | 30x15 cm    |
| 3xxx005 | Massage cushion  | 30x28x8 cm  |
| 3xxx015 | Wedge shaped cushion                                   | 50x30x15 cm |



Available in all colours shown below

| NATURAL                      | LIFESTYLE                    | EXECUTIVE  |
|------------------------------|------------------------------|--|
| 811                      851 | 410                      408 | 012                      213                      199                      204                      169                      170 |



## Rolls and cushions

## ACCESSORIES

1550813 Plug for nosehole, triangular shaped <sup>(1)</sup>

16,5 x 21 cm

3445297 Wedge shaped, Kaltenborn, rubber model <sup>(1)</sup>

22,5 x 10,5 x 8,5 cm

3446161 Support bag with sand 1,2 kg <sup>(2)</sup>

15x25 cm

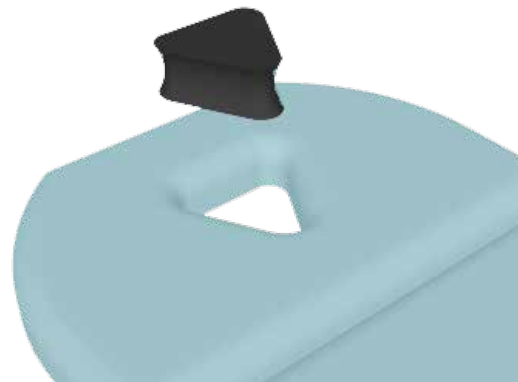

1550813

(1) = only available in black  
(2) = only available in grey



3445297



3446161



# Couch covers

# ACCESSORIES

|         |  |            |
|---------|--|------------|
| 3445240 | Couch cover, with a cutaway for the nose                                 | blue       |
| 3445241 | Couch cover, with a cutaway for the nose                                 | bordeaux   |
| 3445242 | Couch cover, with a cutaway for the nose                                 | white      |
| 3445244 | Couch cover, with a cutaway for the nose                                 | jade       |
| 3445249 | Couch cover, with a cutaway for the nose                                 | dark grey  |
| 3445250 | Couch cover, with a cutaway for the nose                                 | royal blue |
| 3445261 | Couch cover, without a cutaway for the nose                              | blue       |
| 3445034 | Couch cover, without a cutaway for the nose                              | bordeaux   |
| 3445267 | Couch cover, without a cutaway for the nose                              | white      |
| 3445262 | Couch cover, without a cutaway for the nose                              | jade       |
| 3445248 | Couch cover, without a cutaway for the nose                              | dark grey  |
| 3445247 | Couch cover, without a cutaway for the nose                              | royal blue |
| 3445259 | Elastic straps for couch cover with clip fittings at both ends, set of 3 |            |



3445240  
3445261



3445241  
3445034



3445242  
3445267



3445244  
3445262



3445248  
3445249

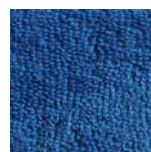

3445247  
3445250



3445259

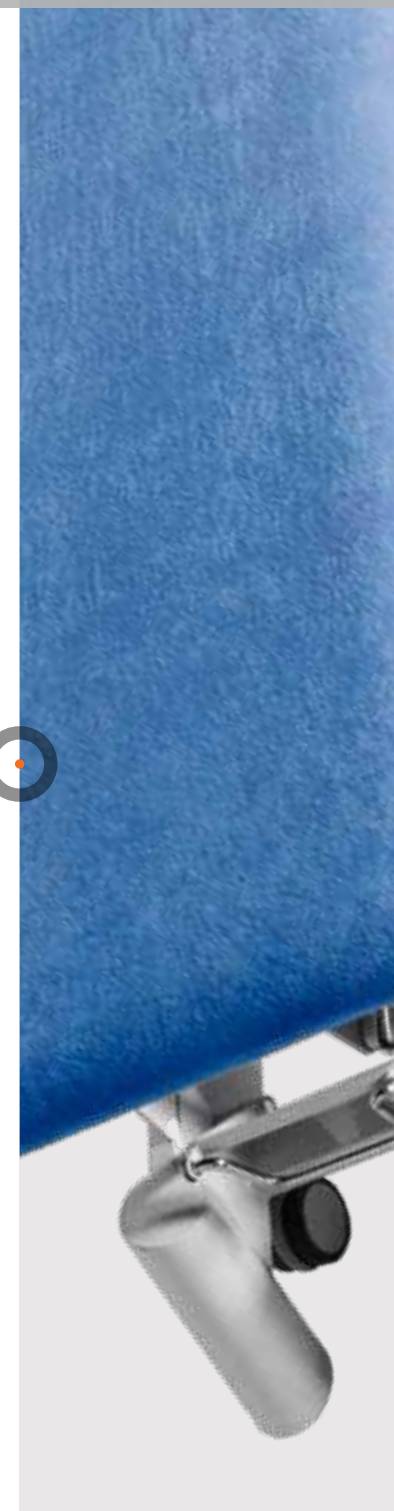

# Manumed Optimal 3-section

## ACCESSORIES

### Gynaecology accessories\*

3496187 Fixation rail for fixation horn armpit or gynaecological set: (1550810 / 1550805 / 3xxx028)

1550810 Gynaecological Comfort set

1550805 Gynaecological set



3496187



1550810



1550805

### Raising set

3450067 Raising set (30 mm)



3450067

\* Only for couches 67 cm wide with flexion position



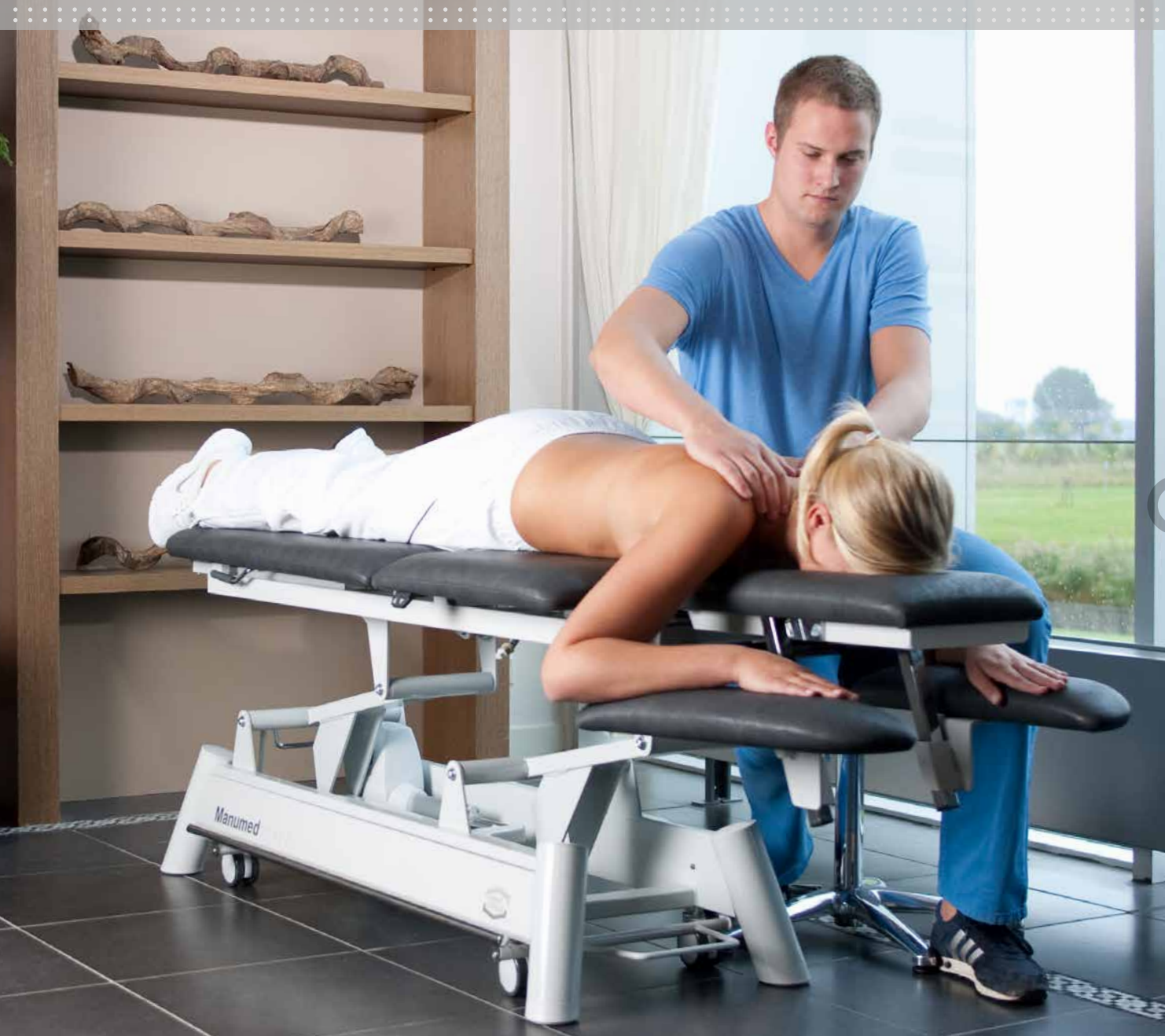

# Manumed Optimal 3-section

The most versatile  
treatment and  
examination couch

Enraf-Nonius B.V. | Vareseweg 127 | 3047 AT Rotterdam | The Netherlands  
www.enraf-nonus.com | info@enraf-nonus.nl | + 31 - ( 0 ) 10 20 30 600



PARTNER FOR LIFE